

## SVA SERIES SOLID STATE RELAY

**SVA-400W025S-1P**  
**SVA-400W040S-1P**  
**SVA-400W050S-1P**  
**SVA-400W075S-1P**  
**SVA-400W090S-1P**

**VR Control AC Loading S.S.R**



## Specifications

MODEL SERIES NO.	CONTROL VOLTAGE	MUST TURN OFF VOLTAGE	INPUT IMPEDANCE	LOADING CURRENT	LOADING VOLTAGE	MIN BLOCKING VOLTAGE	MAX OFF-STATE LEAKAGE	FREQUENCY RANGE	MAX 1-CYCLE PEAK SURGE
SVA-400W025S-1P	VR 0~1MΩ	—	1.5 KΩ	25A	48 ~ 480VAC	1200VAC	LESS 5 mA	47-70HZ	250A
SVA-400W040S-1P	VR 0~1MΩ	—	1.5 KΩ	40A	48 ~ 480VAC	1200VAC	LESS 5 mA	47-70HZ	400A
SVA-400W050S-1P	VR 0~1MΩ	—	1.5 KΩ	50A	48 ~ 480VAC	1200VAC	LESS 5 mA	47-70HZ	500A
SVA-400W075S-1P	VR 0~1MΩ	—	1.5 KΩ	75A	48 ~ 480VAC	1200VAC	LESS 5 mA	47-70HZ	750A
SVA-400W090S-1P	VR 0~1MΩ	—	1.5 KΩ	90A	48 ~ 480VAC	1200VAC	LESS 5 mA	47-70HZ	900A

MODEL SERIES NO.	MAX OFF STATE dv/dt	MAX ON-STATE VOLTAGE DROP	ISOLATE IMPEDENCE	DIELECTRIC STRENGTH INPUT-OUTPUT	DIELECTRIC STRENGTH INPUT,OUTPUT-CASE	TURN ON TIME	TURN OFF TIME	CAPACITANCE IN-OUT	WEIGHT (g)
SVA-400W025S-1P	1000 V/μsec	2.0Vrms	10 <sup>9</sup> Ω	—	4000 VACrms	LESS 2 msec	LESS 1/2 AC CYCLE	LESS 15 PF	100 g
SVA-400W040S-1P	1000 V/μsec	2.0Vrms	10 <sup>9</sup> Ω	—	4000 VACrms	LESS 2 msec	LESS 1/2 AC CYCLE	LESS 15 PF	100 g
SVA-400W050S-1P	1000 V/μsec	2.0Vrms	10 <sup>9</sup> Ω	—	4000 VACrms	LESS 2 msec	LESS 1/2 AC CYCLE	LESS 15 PF	100 g
SVA-400W075S-1P	1000 V/μsec	2.0Vrms	10 <sup>9</sup> Ω	—	4000 VACrms	LESS 2 msec	LESS 1/2 AC CYCLE	LESS 15 PF	100 g
SVA-400W090S-1P	1000 V/μsec	2.0Vrms	10 <sup>9</sup> Ω	—	4000 VACrms	LESS 2 msec	LESS 1/2 AC CYCLE	LESS 15 PF	100 g

## Parts No.

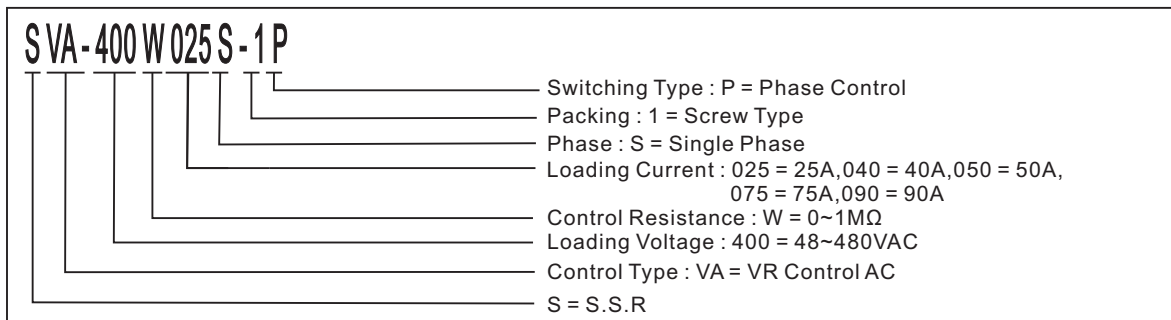

## Outline Dimensions (Unit : mm)

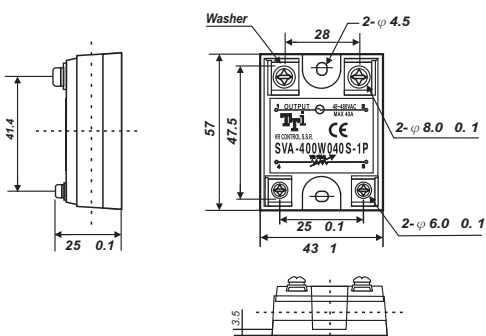

## Characteristic Curves

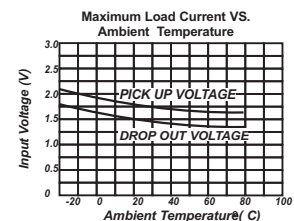
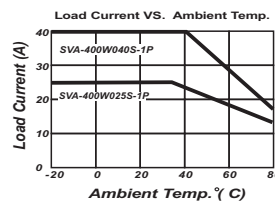
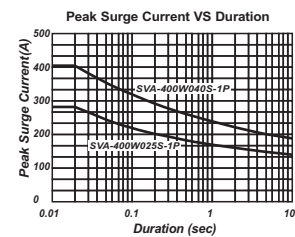
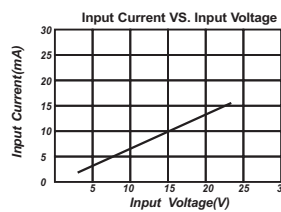

## Equivalent Circuit

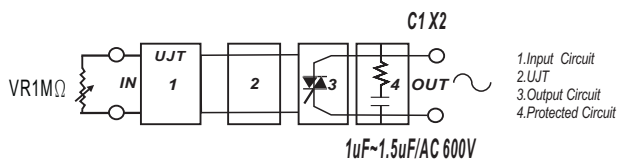

### Attention:

In order to be in compliance with the EMC Directive an additional X2 capacitor at the output is required if the SSR is operated as single component. In case the SSR is incorporated in an appliance the existing EMI filter may provide the required EMI suppression. The X2 capacitor must be placed as close as possible to the output terminals. See also above.